

AT05.V4 LED DOWNLIGHT



* Product features:

- Aesthetic and elegant design, suitable for Korean market
- High-quality LEDs provided by Samsung/ Seoul Semiconductor/ Nichia/ Lumiled with excellent performance
- Aluminum PCB to ensure optimal heat dissipation
- Dust and insect proof design IP20
- High luminous efficacy up to 110 lm/W
- Long lifespan: 25,000 hours, saving the maintenance cost
- Flicker-free, EMC
- KC, CE certified
- Options:
 - + Type 1: AC direct
 - + Type 2: High efficacy
 - + Type 3: 3-CCT Changeable - AC direct
 - + Type 4: 3-CCT Changeable - High efficacy
 - + Type 5: 3-Step Dimming
 - + Type 6: PIR sensor

* Applications:

- Offices, schools, houses, commercial buildings, hospitals, etc.

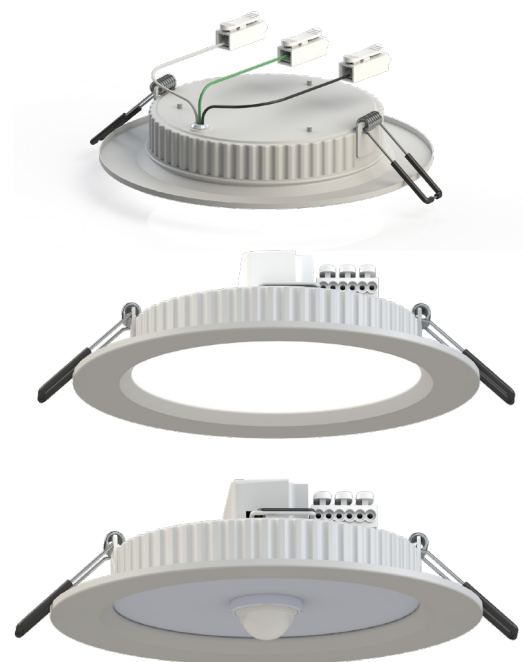

TYPE 1: AC DIRECT

PRODUCT FEATURES

- DOB driver
- Aluminum PCB
- Metal housing with powder coating finish for better heat dissipation
- LED provided by Samsung, Seoul semiconductor
- Various sizes available with power ranges from 7 to 30W

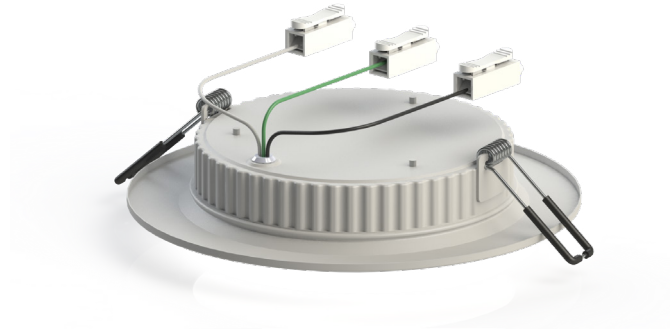

3/4/5/6/8-inch



PRODUCT DETAILS

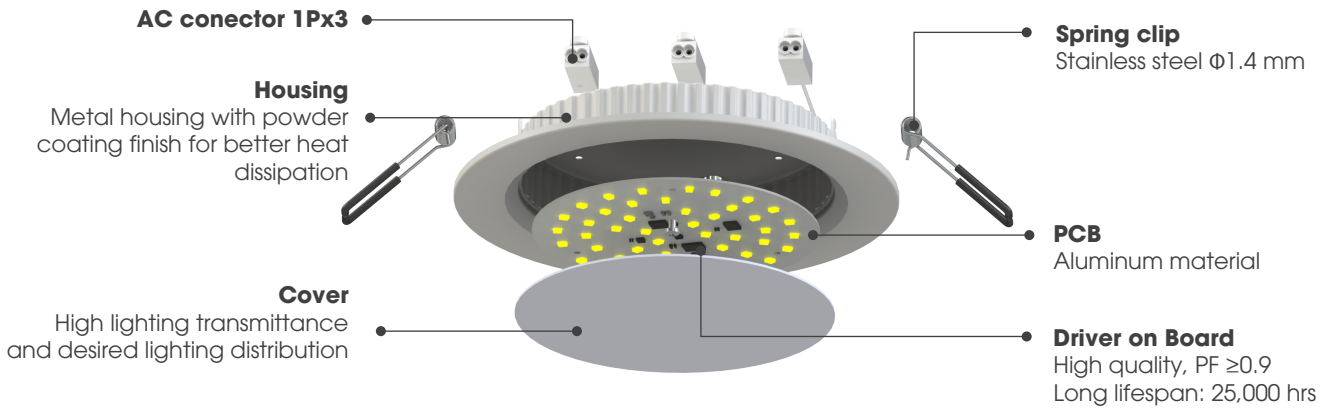

PRODUCT SPECIFICATIONS

| Model | Dimension $\text{Ø} \times \text{H}$ (mm) | Power (W) | Voltage/ Frequency (V/Hz) | Power factor | Luminous flux (lm) | Luminous Efficacy (lm/W) | CCT (K) | Beam angle (°) | Cut out Øc (mm) | Lifespan (hrs) | Market |
|-----------------------|---|-----------|---------------------------|--------------|--------------------|--------------------------|---------|----------------|--------------------------|----------------|--------|
| AT05.V4-AC-3IN-7W | 98x26 | 7 | 220/60 | >0.9 | 630 | 90 | 5700 | 110 | 70 | 25,000 | |
| AT05.V4-AC-4IN-10W | 120x26 | 10 | 220/60 | >0.9 | 900 | 90 | 5700 | 110 | 90 | 25,000 | |
| AT05.V4-AC-5IN-12W | 146x28 | 12 | 220/60 | >0.9 | 1080 | 90 | 5700 | 110 | 110 | 25,000 | |
| AT05.V4-AC-6IN-15W | 180x28 | 10 | 220/60 | >0.9 | 1350 | 90 | 5700 | 110 | 155 | 25,000 | |
| AT05.V4-AC-6IN-15W.HE | 180x28 | 12 | 220/60 | >0.9 | 1575 | 105 | 5700 | 110 | 155 | 25,000 | |
| AT05.V4-AC-6IN-20W | 180x28 | 15 | 220/60 | >0.9 | 1800 | 90 | 5700 | 110 | 155 | 25,000 | |
| AT05.V4-AC-8IN-30W | 220x32 | 20 | 220/60 | >0.9 | 2700 | 90 | 5700 | 110 | 200 | 25,000 | |
| AT05.V4-AC-8IN-30W.HE | 220x32 | 30 | 220/60 | >0.9 | 3300 | 110 | 5700 | 110 | 200 | 25,000 | |

TYPE 2: HIGH EFFICACY

PRODUCT FEATURES

- High luminous efficacy (over 105lm/W)
- Aluminum PCB
- Metal housing with powder coating finish for better heat dissipation
- LED provided by Samsung, Seoul semiconductor
- Power factor ≥ 0.9 , flicker free
- Wide voltage range: 170 ÷ 250V

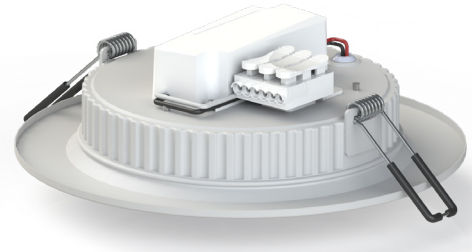

3/4/5/6/8-inch



PRODUCT DETAILS

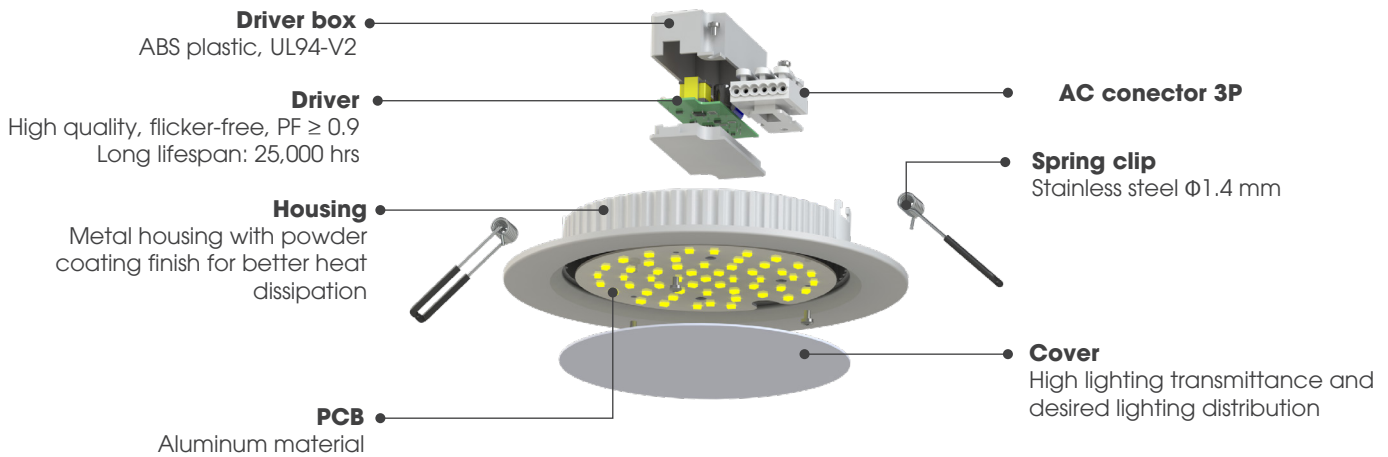

PRODUCT SPECIFICATIONS

| Model | Dimension $\Phi \times H$ (mm) | Power (W) | Voltage/ Frequency (V/Hz) | Power factor | Luminous flux (lm) | Luminous Efficacy (lm/W) | CCT (K) | Beam angle ($^{\circ}$) | Cut out ϕ_c (mm) | Lifespan (hrs) | Market |
|--------------------|--------------------------------|-----------|---------------------------|--------------|--------------------|--------------------------|---------|---------------------------|-----------------------|----------------|--------|
| AT05.V4-3IN-7W.HE | 98x26 | 7 | 220/60 | ≥ 0.9 | 735 | 105 | 5700 | 110 | 70 | 25,000 | |
| AT05.V4-4IN-10W.HE | 120x26 | 10 | 220/60 | ≥ 0.9 | 1050 | 105 | 5700 | 110 | 90 | 25,000 | |
| AT05.V4-5IN-12W.HE | 146x28 | 12 | 220/60 | ≥ 0.9 | 1260 | 105 | 5700 | 110 | 110 | 25,000 | |
| AT05.V4-6IN-10W.HE | 180x52 | 10 | 220/60 | ≥ 0.9 | 1050 | 105 | 5700 | 110 | 155 | 25,000 | |
| AT05.V4-6IN-12W.HE | 180x52 | 12 | 220/60 | ≥ 0.9 | 1260 | 105 | 5700 | 110 | 155 | 25,000 | |
| AT05.V4-6IN-15W.HE | 180x52 | 15 | 220/60 | ≥ 0.9 | 1575 | 105 | 5700 | 110 | 155 | 25,000 | |
| AT05.V4-6IN-20W.HE | 180x52 | 20 | 220/60 | ≥ 0.9 | 2100 | 105 | 5700 | 110 | 155 | 25,000 | |
| AT05.V4-8IN-30W.HE | 220x56 | 30 | 220/60 | ≥ 0.9 | 3300 | 110 | 5700 | 110 | 200 | 25,000 | |

TYPE 3: 3-CCT CHANGEABLE-AC DIRECT

PRODUCT FEATURES

- CCT can be adjusted by wall switch: 3000K - 4000K - 6500K
- DOB driver
- AC voltage range: 200 ÷ 240V
- Power factor ≥ 0.9
- Metal housing with powder coating finish for better heat dissipation
- LED provided by Samsung, Seoul semiconductor

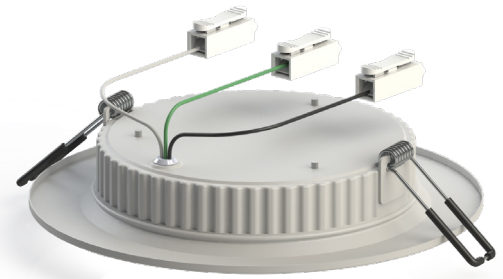

6/8-inch



PRODUCT DETAILS

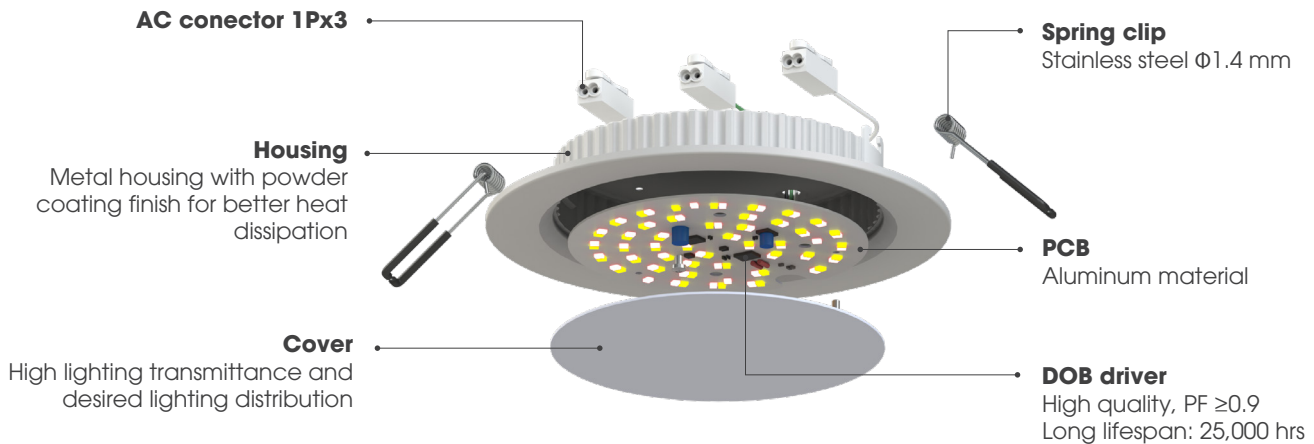

PRODUCT SPECIFICATIONS

| Model | Dimension $\Phi \times H$ (mm) | Power (W) | Voltage/ Frequency (V/Hz) | Power factor | Luminous flux (lm) | Luminous Efficacy (lm/W) | CCT (K) | Beam angle ($^{\circ}$) | Cut out Φc (mm) | Life span (hrs) | Market |
|------------------------|-----------------------------------|--------------|------------------------------|-----------------|--------------------------|--------------------------------|----------------|---------------------------------|--------------------------|--------------------|--------|
| AT05.V4-AC-6IN-10W.CCT | 180x28 | 10 | 220/60 | ≥ 0.9 | 900 | 90 | 3000-4000-6500 | 110 | 155 | 25,000 | |
| AT05.V4-AC-6IN-12W.CCT | 180x28 | 12 | 220/60 | ≥ 0.9 | 1080 | 90 | 3000-4000-6500 | 110 | 155 | 25,000 | |
| AT05.V4-AC-6IN-15W.CCT | 180x28 | 15 | 220/60 | ≥ 0.9 | 1350 | 90 | 3000-4000-6500 | 110 | 155 | 25,000 | |
| AT05.V4-AC-6IN-20W.CCT | 180x28 | 20 | 220/60 | ≥ 0.9 | 1800 | 90 | 3000-4000-6500 | 110 | 155 | 25,000 | |
| AT05.V4-AC-8IN-30W.CCT | 220x32 | 30 | 220/60 | ≥ 0.9 | 2700 | 90 | 3000-4000-6500 | 110 | 200 | 25,000 | |

TYPE 4: 3-CCT CHANGEABLE - HIGH EFFICACY

PRODUCT FEATURES

- CCT can be adjusted by wall switch: 3000K - 4000K - 6500K
- High luminous efficacy (over 105lm/W)
- Power factor ≥ 0.9 , flicker free
- Wide voltage range: 170 ÷ 260V
- Metal housing with powder coating finish for better heat dissipation
- LED provided by Samsung, Seoul semiconductor

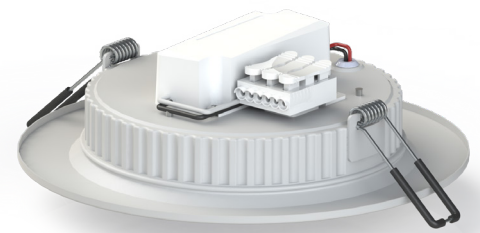

3/4/5/6/8-inch



PRODUCT DETAILS

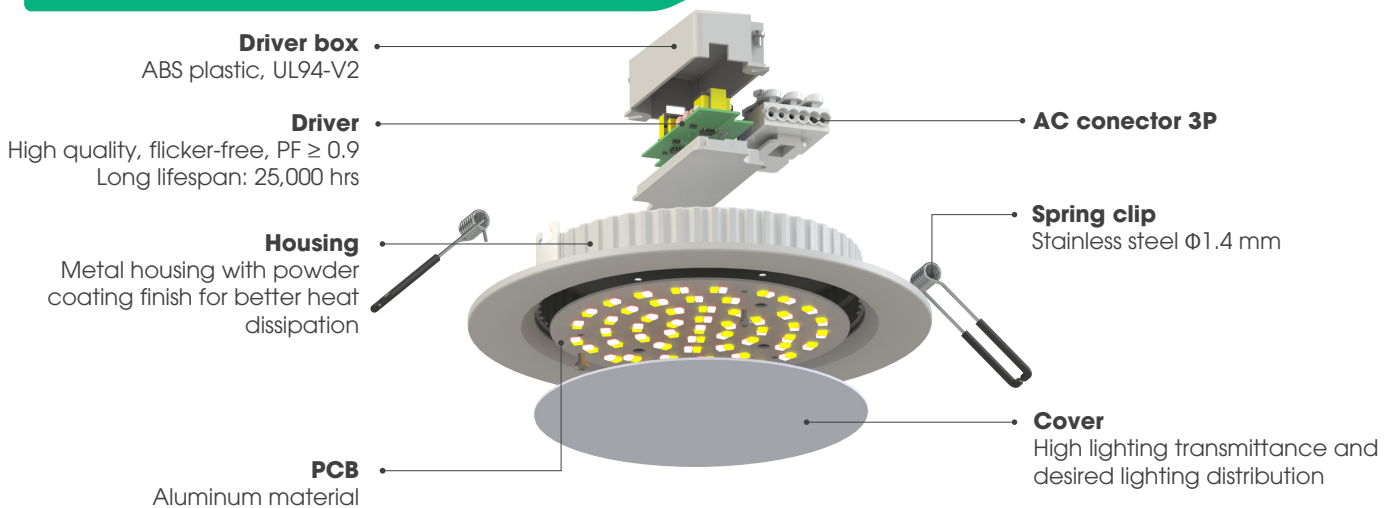

PRODUCT SPECIFICATIONS

| Model | Dimension $\Phi \times H$ (mm) | Power (W) | Voltage/Frequency (V/Hz) | Power factor | Luminous flux (lm) | Luminous Efficacy (lm/W) | CCT (K) | Beam angle (°) | Cut out Φ_c (mm) | Lifespan (hrs) | Market |
|------------------------|--------------------------------|-----------|--------------------------|--------------|--------------------|--------------------------|-----------------|----------------|-----------------------|----------------|--------|
| AT05.V4-3IN-7W.HE.CCT | 98x26 | 7 | 220/60 | ≥ 0.9 | 735 | 705 | 10000-4000-6500 | 110 | 770 | 25,000 | |
| AT05.V4-4IN-10W.HE.CCT | 120x26 | 10 | 220/60 | ≥ 0.9 | 1050 | 1050 | 10000-4000-6500 | 110 | 980 | 25,000 | |
| AT05.V4-5IN-12W.HE.CCT | 146x28 | 12 | 220/60 | ≥ 0.9 | 1260 | 1260 | 10000-4000-6500 | 110 | 1110 | 25,000 | |
| AT05.V4-6IN-10W.HE.CCT | 180x52 | 10 | 220/60 | ≥ 0.9 | 1050 | 1050 | 10000-4000-6500 | 110 | 1355 | 25,000 | |
| AT05.V4-6IN-12W.HE.CCT | 180x52 | 12 | 220/60 | ≥ 0.9 | 1260 | 1260 | 10000-4000-6500 | 110 | 1355 | 25,000 | |
| AT05.V4-6IN-15W.HE.CCT | 180x52 | 15 | 220/60 | ≥ 0.9 | 1575 | 1575 | 10000-4000-6500 | 110 | 1355 | 25,000 | |
| AT05.V4-6IN-20W.HE.CCT | 180x52 | 20 | 220/60 | ≥ 0.9 | 2100 | 2100 | 10000-4000-6500 | 110 | 1355 | 25,000 | |
| AT05.V4-8IN-30W.HE.CCT | 220x56 | 30 | 220/60 | ≥ 0.9 | 3300 | 3300 | 10000-4000-6500 | 110 | 2000 | 25,000 | |

TYPE 5: 3-STEP DIMMING

PRODUCT FEATURES



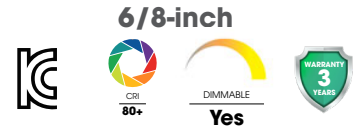
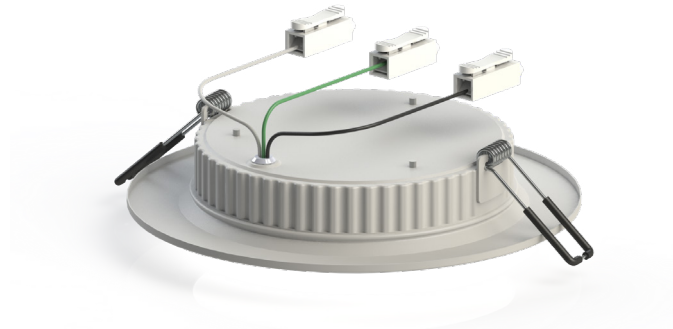

- Dimmable at 3 levels of brightness by wall switch: 100% - 50% - 20%
- DOB driver
- AC voltage range: 200 ÷ 240V
- Power factor ≥ 0.9
- Metal housing with powder coating finish for better heat dissipation
- LED provided by Samsung, Seoul semiconductor

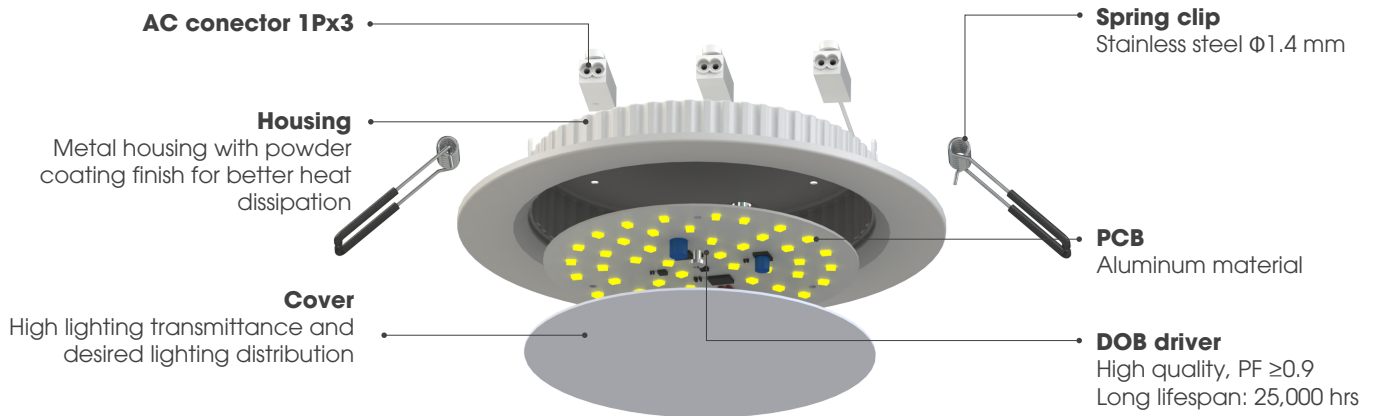

PRODUCT DETAILS



PRODUCT SPECIFICATIONS

| Model | Dimension $\Phi \times H$ (mm) | Power (W) | Voltage/ Frequency (V/Hz) | Power factor | Luminous flux (lm) | Luminous Efficacy (lm/W) | CCT (K) | Beam angle ($^\circ$) | Cut out Φc (mm) | Life span (hrs) | Market |
|------------------------|--------------------------------|-----------|---------------------------|--------------|--------------------|--------------------------|---------|-------------------------|-----------------------|-----------------|---|
| AT05.V4-AC-6IN-10W.DIM | 180x28 | 10 | 220/60 | ≥ 0.9 | 900 | 90 | 5700 | 110 | 155 | 25,000 |  |
| AT05.V4-AC-6IN-12W.DIM | 180x28 | 12 | 220/60 | ≥ 0.9 | 1080 | 90 | 5700 | 110 | 155 | 25,000 |  |
| AT05.V4-AC-6IN-15W.DIM | 180x28 | 15 | 220/60 | ≥ 0.9 | 1350 | 90 | 5700 | 110 | 155 | 25,000 |  |
| AT05.V4-AC-6IN-20W.DIM | 180x28 | 20 | 220/60 | ≥ 0.9 | 1800 | 90 | 5700 | 110 | 155 | 25,000 |  |
| AT05.V4-AC-8IN-30W.DIM | 220x32 | 30 | 220/60 | ≥ 0.9 | 2700 | 90 | 5700 | 110 | 200 | 25,000 |  |

TYPE 6: PIR SENSOR

PRODUCT FEATURES

- Built-in PIR sensor has a detection distance of 3-4 meters, with a 90o angle of detection
- High luminous efficacy (over 105lm/W)
- Power factor ≥ 0.9 , flicker free
- Wide voltage range: 170 ÷ 250V
- Metal housing with powder coating finish for better heat dissipation
- LED provided by Samsung, Seoul semiconductor

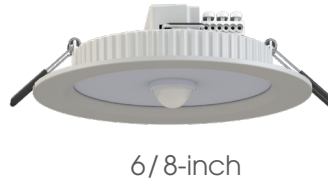

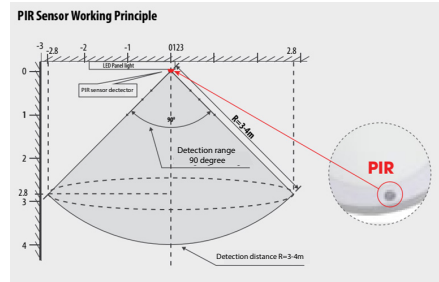

6/8-inch

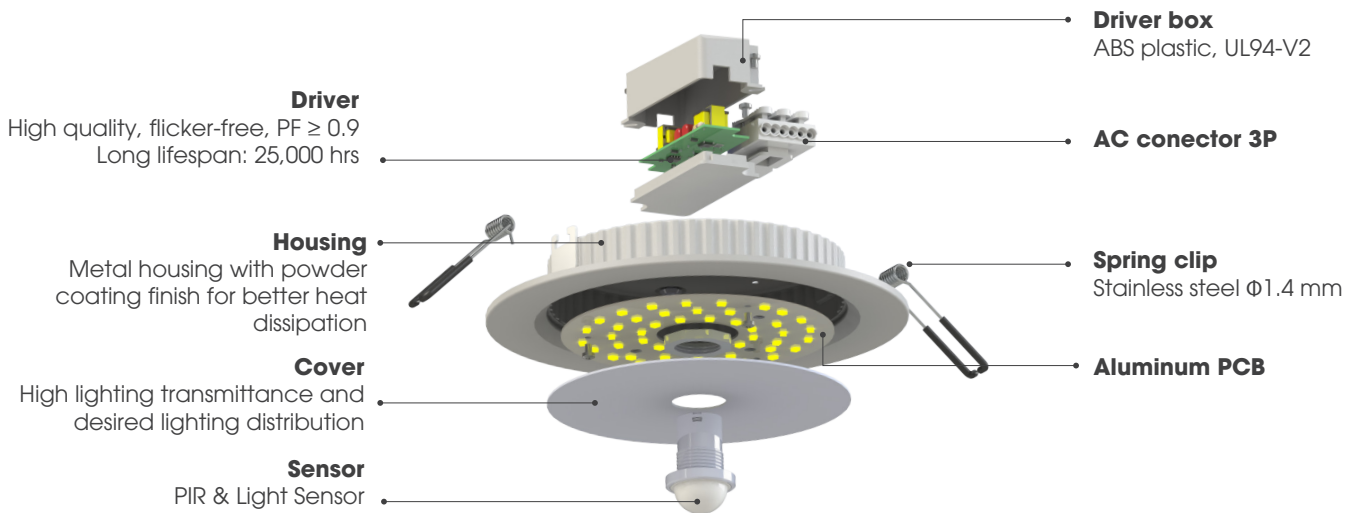

PRODUCT DETAILS



PRODUCT SPECIFICATIONS

| Model | Dimension $\Phi \times H$ (mm) | Power (W) | Voltage/ Frequency (V/Hz) | Power factor | Luminous flux (lm) | Luminous Efficacy (lm/W) | CCT (K) | Beam angle ($^{\circ}$) | Cut out Φc (mm) | Lifespan (hrs) | Market |
|------------------------|--------------------------------|-----------|---------------------------|--------------|--------------------|--------------------------|---------|---------------------------|-----------------------|----------------|---|
| AT05.V4-6IN-15W.HE.PIR | 180x28 | 15 | 220/60 | ≥ 0.9 | 1575 | ≥ 105 | 5700 | 110 | 155 | 25,000 |  |
| AT05.V4-6IN-20W.HE.PIR | 180x28 | 20 | 220/60 | ≥ 0.9 | 2100 | ≥ 105 | 5700 | 110 | 155 | 25,000 |  |

Capacity: 11.2 million pieces per year

Customizable: Power (7/10/12/15/20/30W), Voltage (120/220÷240/100÷277), PF (05/09), lm/W (90/105/110), CCT (3000/4000/5000/5700/6500K), lifespan, etc

LUMINOUS INTENSITY DISTRIBUTION

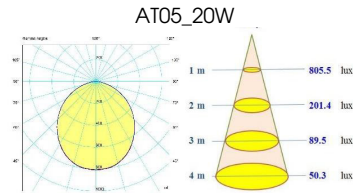
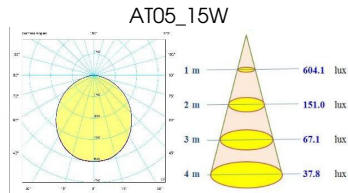
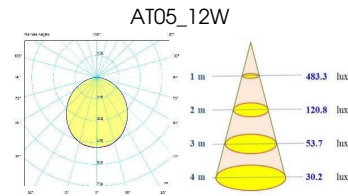
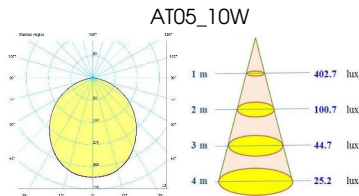

PACKING AND TRANSPORTATION



| Type of lamps | Quantity in master box (pcs) | Estimated quantity/ 20'DC (pcs) | Estimated quantity/ 40'HC (pcs) |
|--|------------------------------|---------------------------------|---------------------------------|
| AT05.V4 3IN/7W, AC-IC driver | 24 | 80 832 | 185 640 |
| AT05.V4 3IN/7W, Buck driver | 24 | 46 800 | 107 448 |
| AT05.V4 4IN/10W, AC-IC driver | 24 | 50 808 | 116 664 |
| AT05.V4 4IN/10W, Buck driver | 24 | 32 640 | 74 952 |
| AT05.V4 5IN/10W, AC-IC driver | 24 | 30 432 | 69 888 |
| AT05.V4 5IN/10W, Buck driver | 24 | 28 392 | 65 184 |
| AT05.V4 6IN/10/12/15/20W, AC-IC driver | 12 | 19 212 | 44 124 |
| AT05.V4 6IN/10/12/15/20W, Buck driver | 12 | 12 948 | 29 748 |
| AT05.V4 8IN/30W, AC-IC driver | 12 | 9 288 | 21 336 |
| AT05.V4 8IN/30W, Buck driver | 12 | 6 792 | 15 588 |



Exported market: South Korea, EU, etc



RANG DONG LIGHT SOURCE AND VACUUM FLASK JOINT STOCK COMPANY

Add: 87- 89 Ha Dinh Street, Thanh Xuan, Hanoi, Vietnam

Tel: (84-24) 3 858 4310 / 3 858 4165

Fax: (84-24) 3 858 5038

Email: export@rangdong.com.vn



Specifications are subject to change without prior notice